

Version: 9.0

Question: 1

DRAG DROP

You have been tasked with creating a vSphere 6.x data center design for an organization. The customer has decided to virtualize their database application and has provided specific design requirements. You must determine how these requirements map to the design characteristic(s).

Match Database Requirements with Design Characteristics by dragging the red button (R1-R5) over the text of the appropriate Design Characteristic.

NOTE: Database Requirements can be mapped to more than one Design Characteristic.

Database Requirements

R1	The design must provide enough resources to handle peak utilization times.
R2	The design must support the required average transaction count.
R3	The database application is mission critical.
R4	The design should support 7 days of transaction logs.
R5	The design should be able to gather I/O statistics for the application.

Design Characteristics

Availability
Manageability
Performance
Recoverability
Security

Answer:

Database Requirements

R1	The design must provide enough resources to handle peak utilization times.
R2	The design must support the required average transaction count.
R3	The database application is mission critical.
R4	The design should support 7 days of transaction logs.
R5	The design should be able to gather I/O statistics for the application.

Design Characteristics

Availability	R3
Manageability	R1
Performance	R2 R5
Recoverability	R4
Security	

Question: 2

Customer Requirements:

You have been tasked with creating a vSphere 6.x data center design for an organization. The organization has produced two 24 port FC switches, and Asymmetrical Active/Active storage array (2 storage Processors with 4 ports each) and 22 ESXi Hosts with 2 dual port HBAs in each. Due to budgetary constraints, the organization cannot purchase anymore equipment. They have provided the following requirements:

- The existing Fibre Channel (FC) Asymmetrical Active/Active Array and FC switches must be used.
- No single point of failure to any datastore.
- Configuration must provide failover and load balancing.
- The customer requires a solution that will accommodate virtual machines with three different I/O load requirements:
 - Static web virtual machines
 - Critical application virtual machines.
 - Object storage for their database virtual machines.

Design Requirements:

Create a logical design that be applied to each of the ESXi Hosts. The design should meet, but not exceed the customer's requirements and should include:

- All required hardware
- All required resources

Place the required datastore(s) in the storage array(s). Connect the storage processor(s) to the storage array(s). Connect the switch(es) to the storage processor(s) and HBA(s). Connect the ESXi host to the HBA(s) and Path Selection Policies.

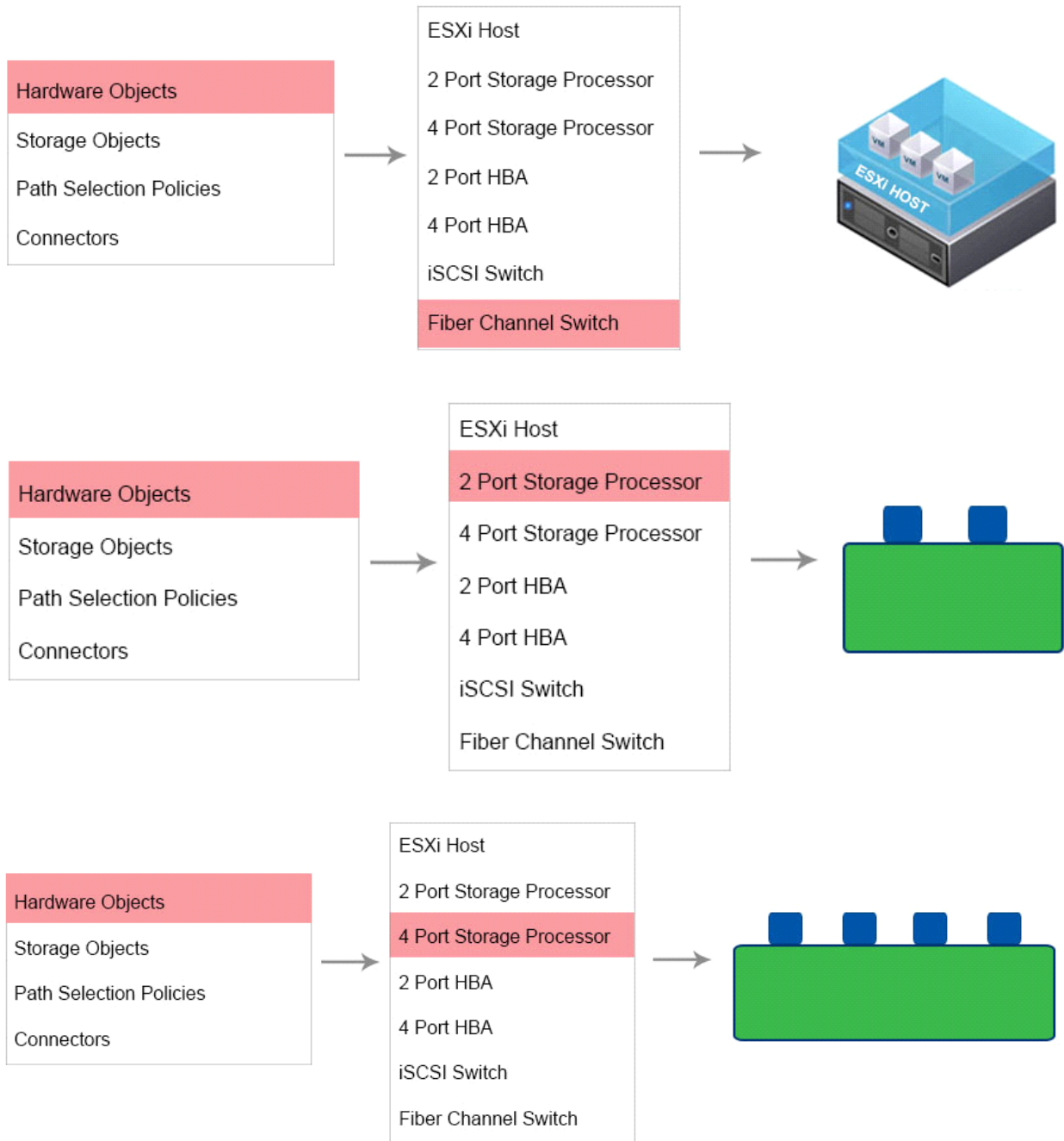

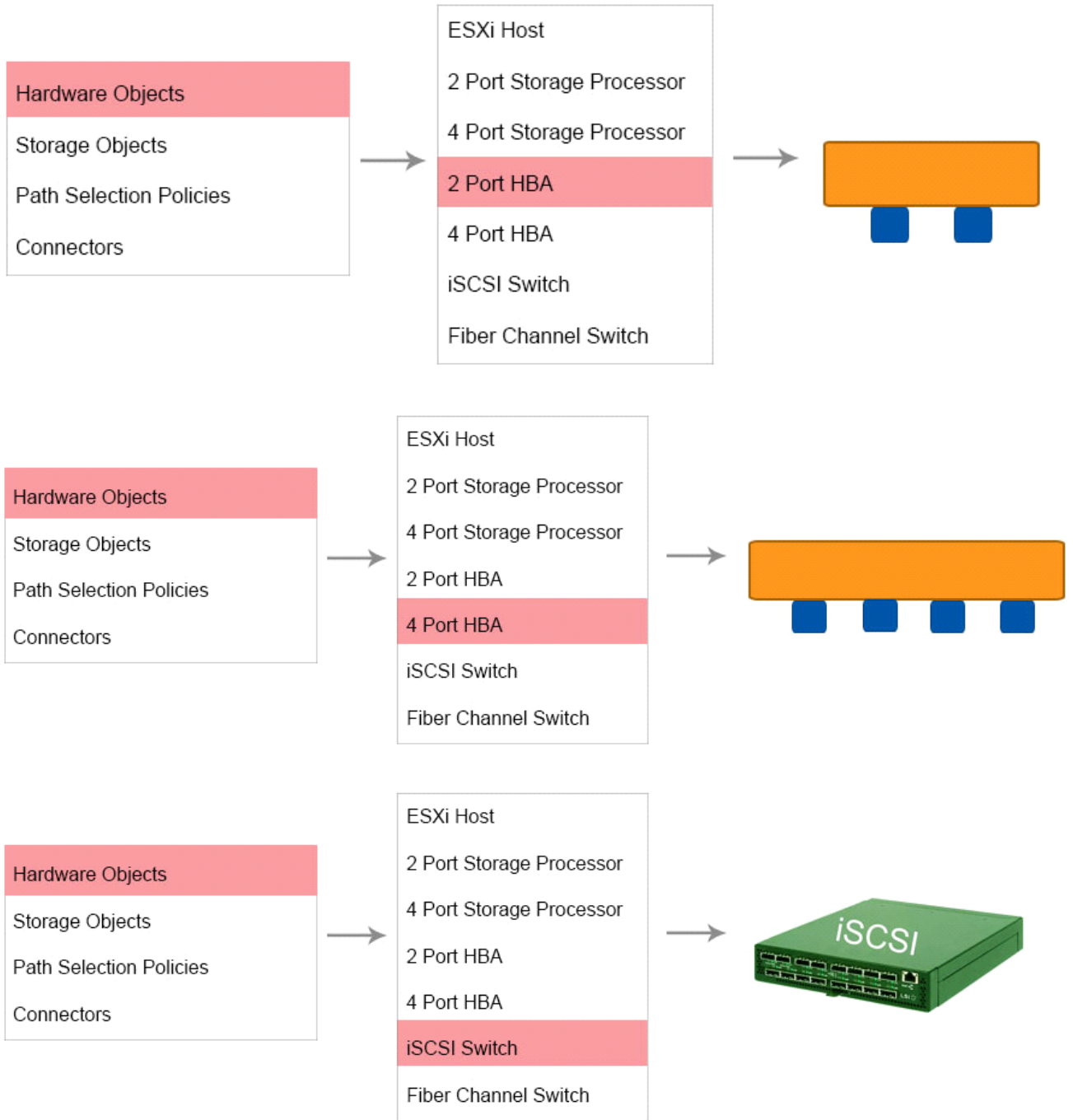

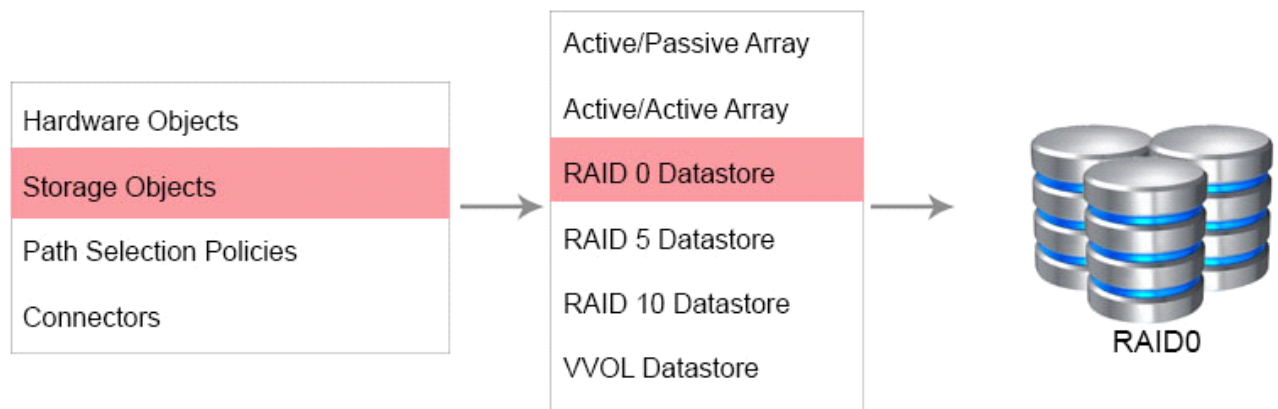
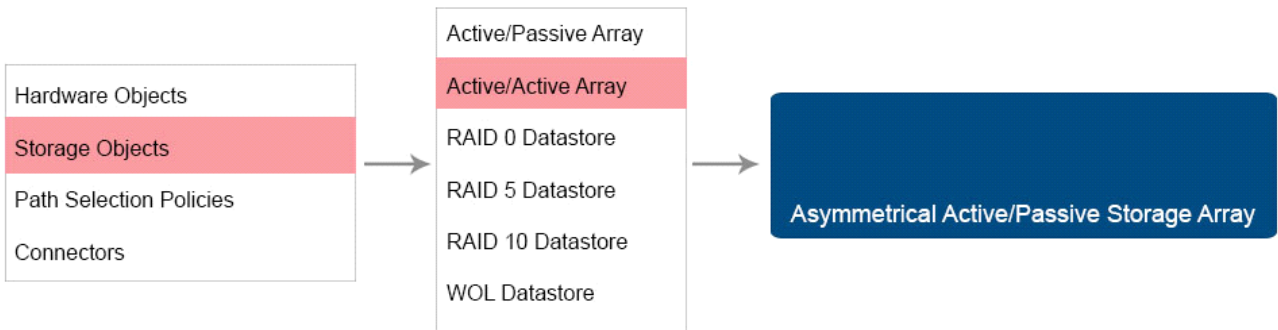
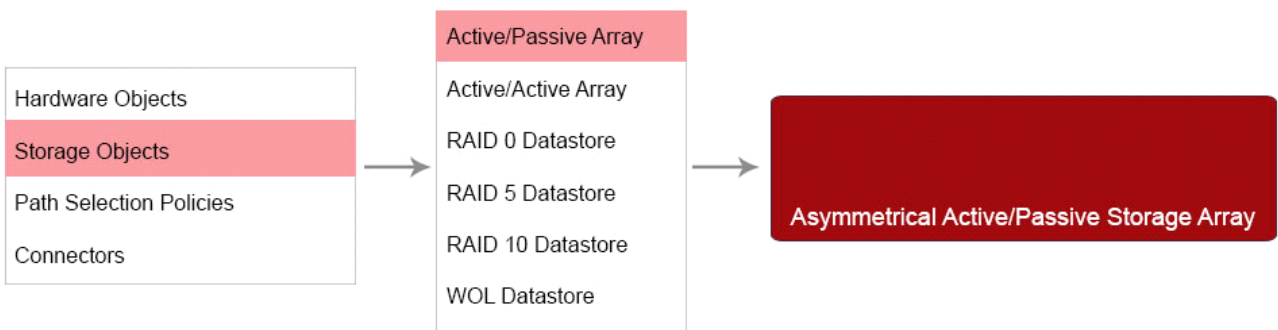
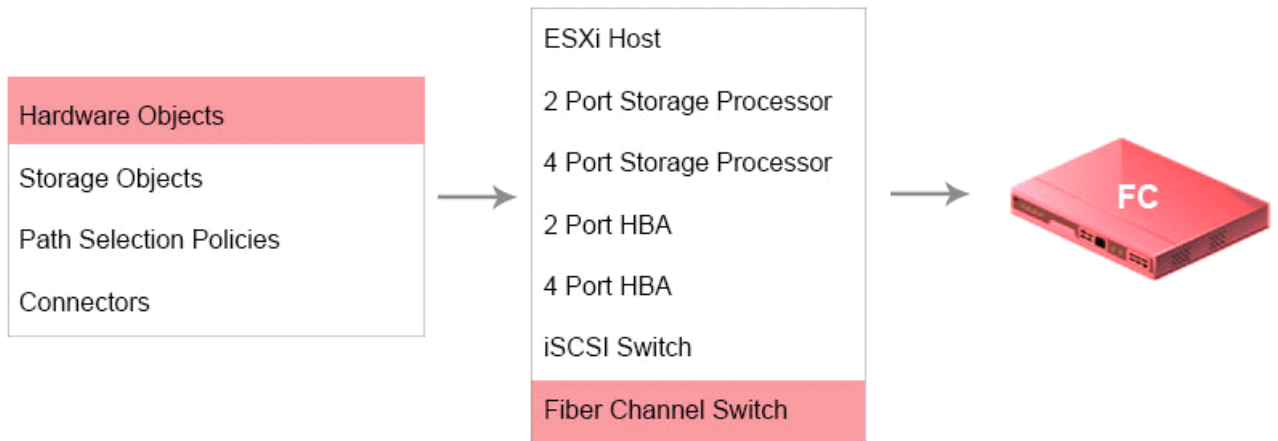

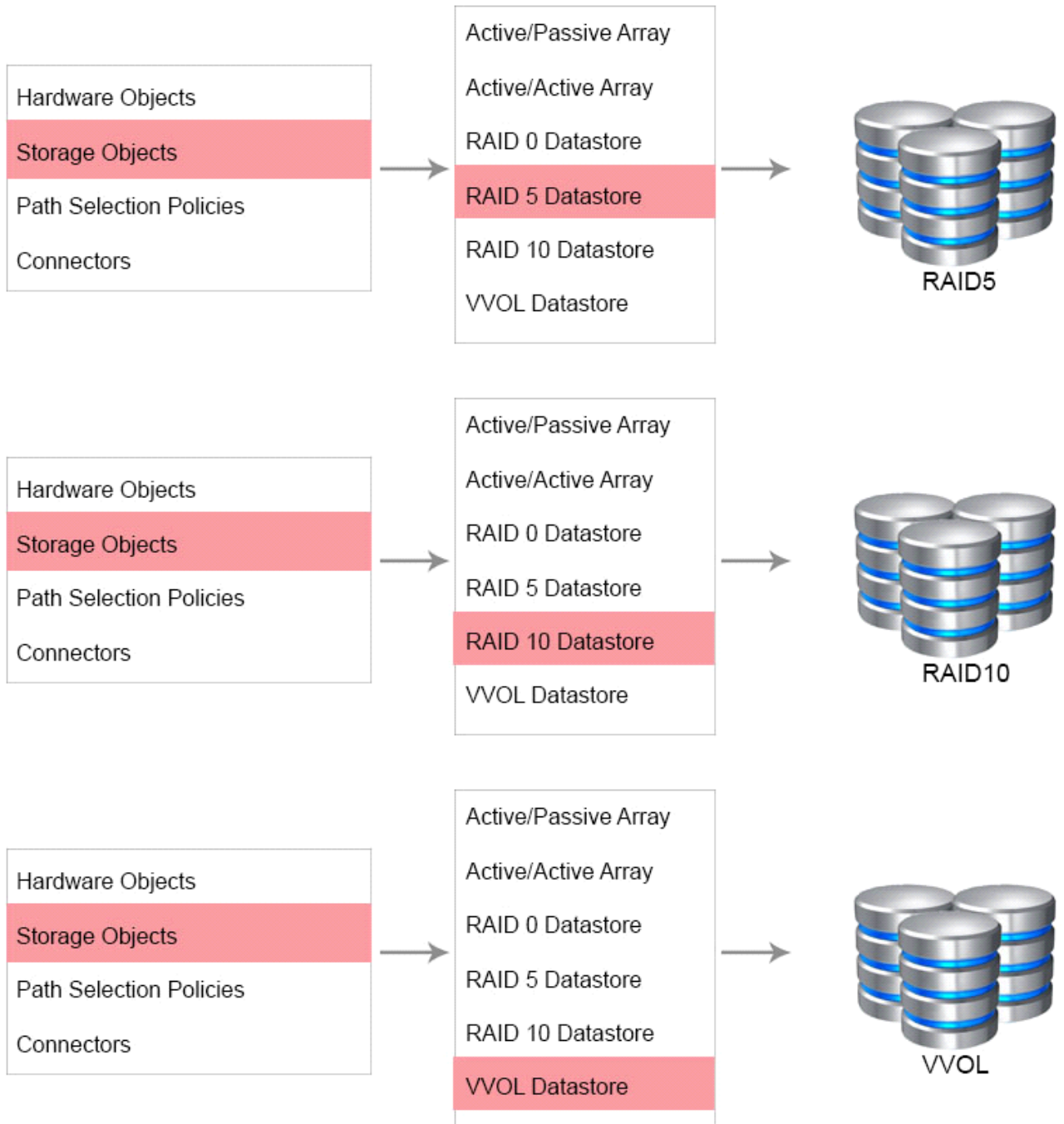

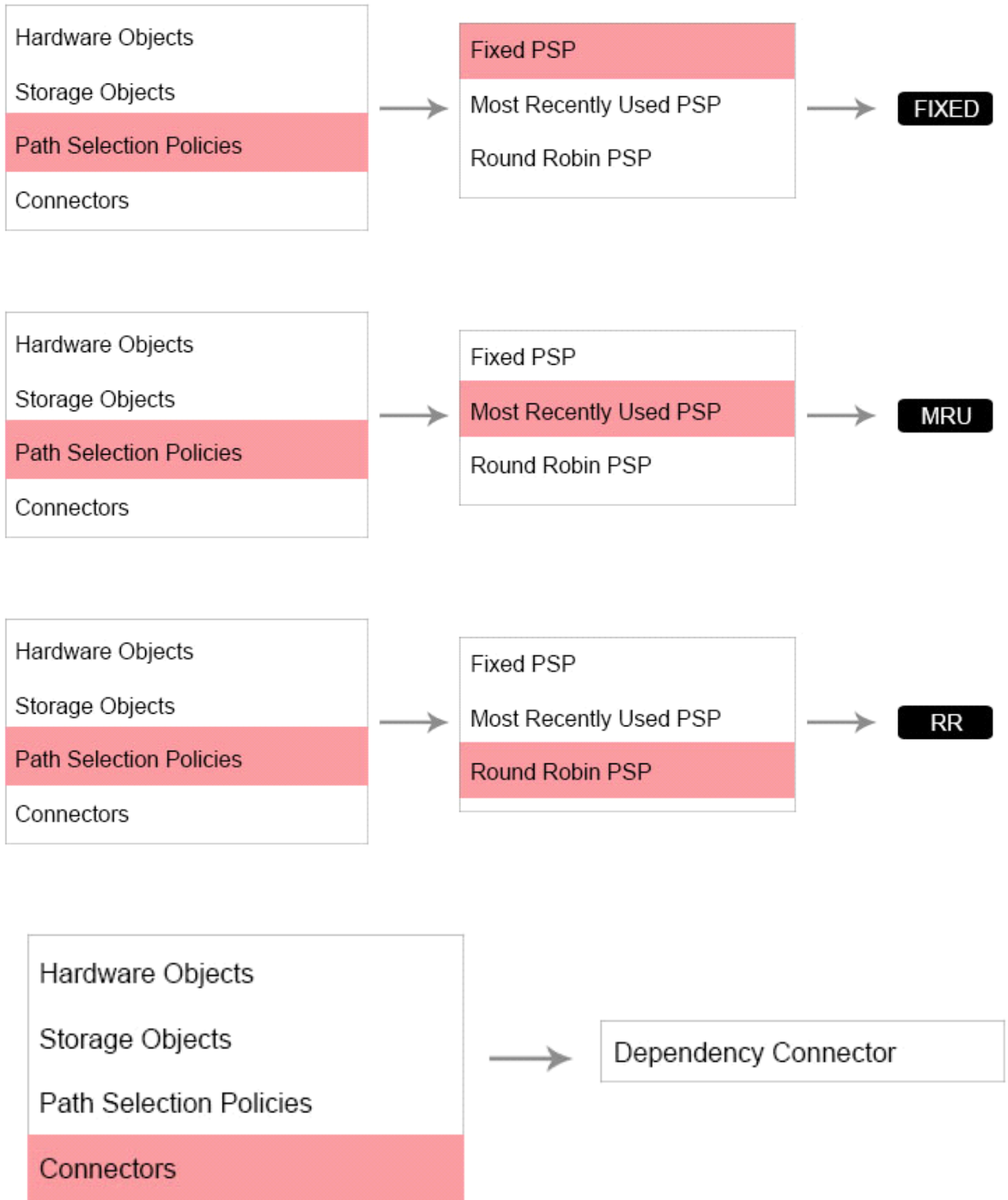

Answer:

See the solution below
Check below for answer solution

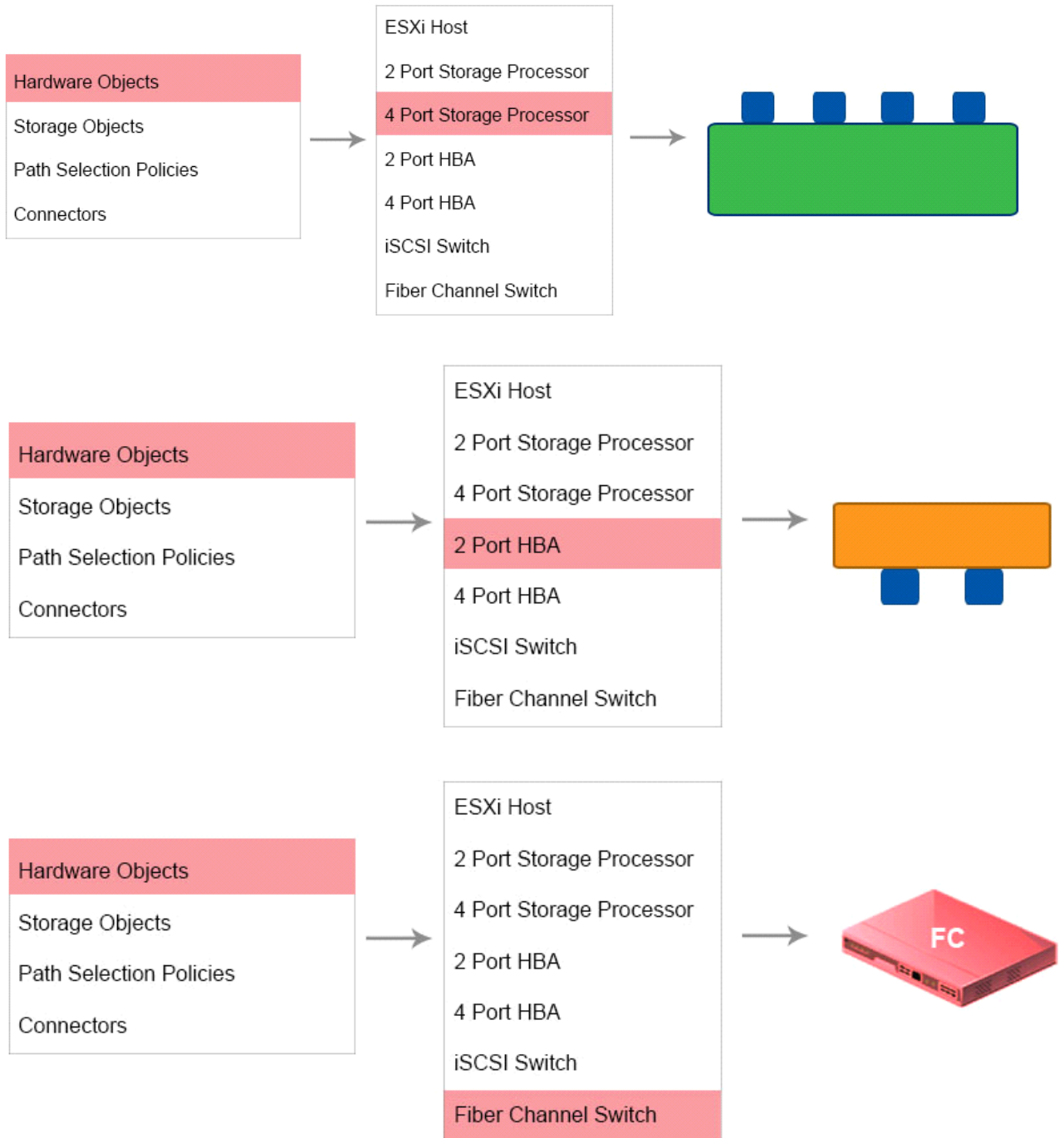

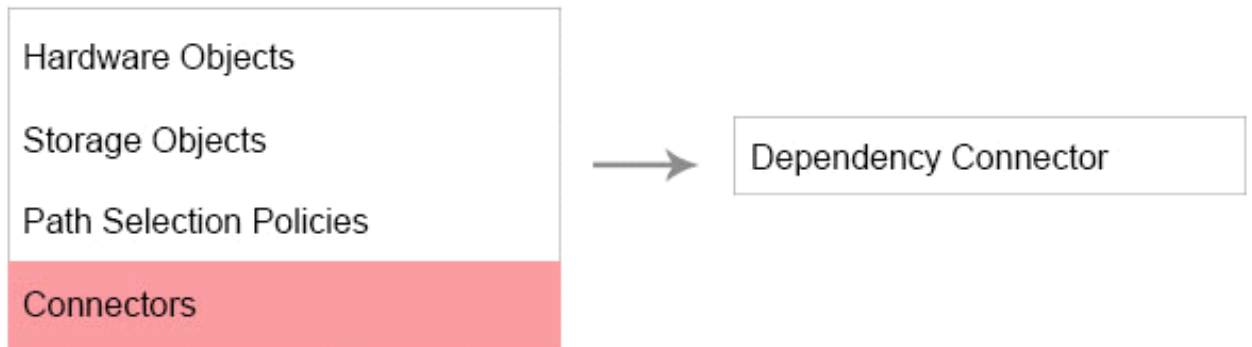
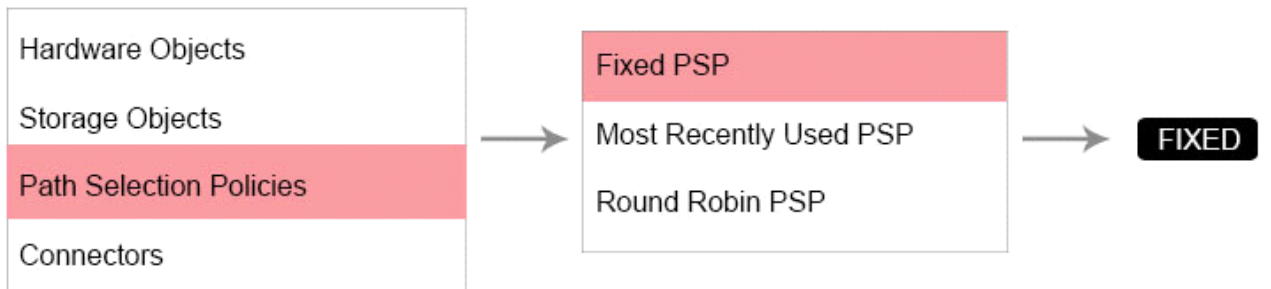
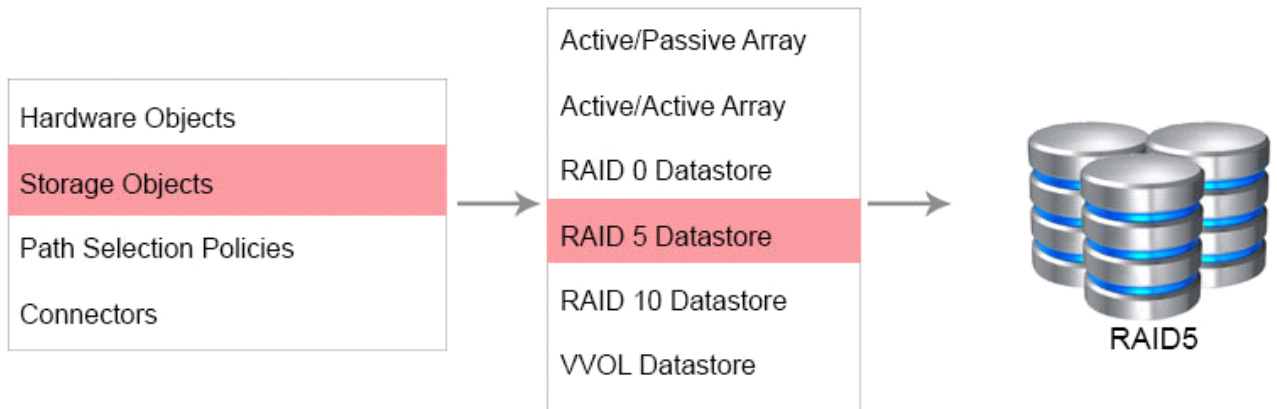
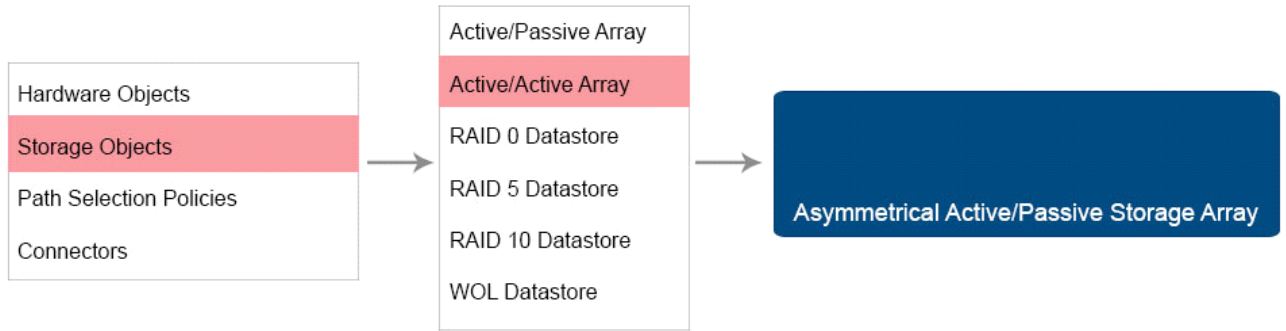

Question: 3

Customer Requirements:

You have been tasked with creating a vSphere 6.x data center design for an organization. The organization is looking to virtualize their physical email application. The company has provided a list of requirements that must be included in the design:

- E-mail database is replicated between two servers at a logical level, with no shared disk configurations.
- E-mail databases meet corporate criteria for LUN provisioning, and must reside directly on storage array.
- Operating system disks do not meet corporate requirements for LUN provisioning, and per policy should not share the same VMFS storage location for redundancy reasons.
- Internal users currently point to three Client Access Servers for load balancing.
- External users currently point to three Web Client Access Servers for load balancing.
- Customer requires discrete hardware to provide security between internal servers and externally available servers, as well as between externally available servers, and client connections from offsite.

Design Requirements:

Create a solution that shows the service dependencies required for virtualizing the email application, including:

- All required storage for Mail DB VM(s) only
- All required network and security connection(s)
- All required virtual machine(s)
- All required user(s)

Place all items in required container(s). Connect VMFS datastore(s) to required virtual machine(s). Place disk(s) over the required storage type(s). Connect firewall(s) to container(s).

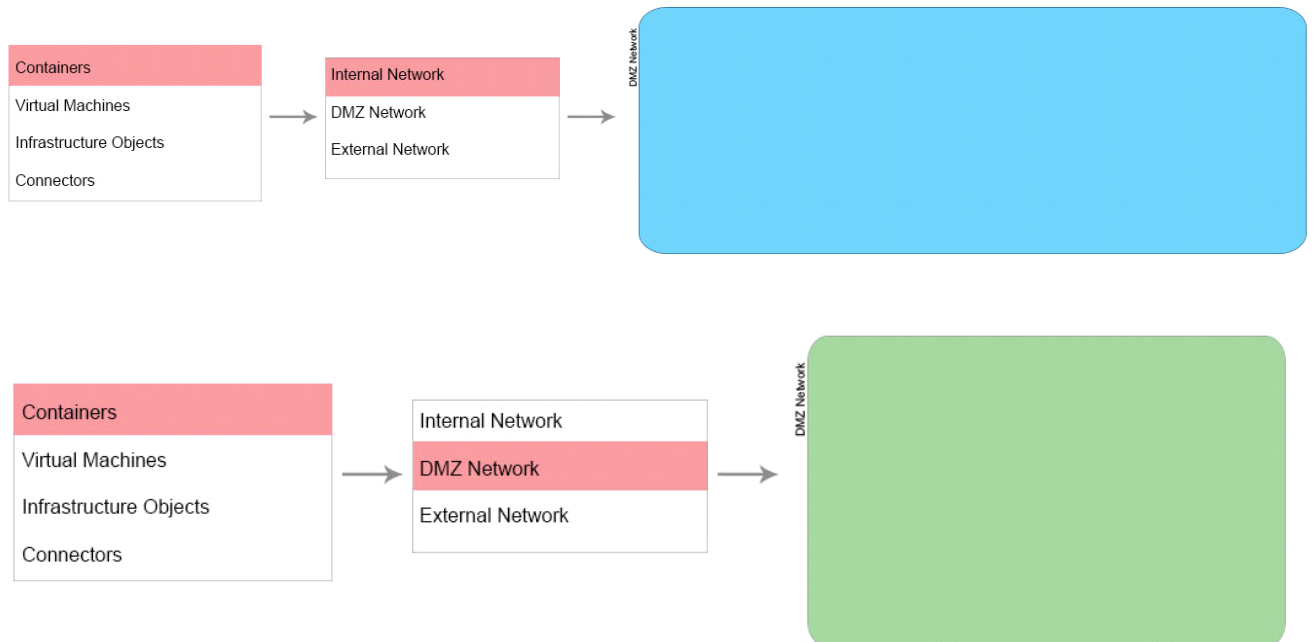

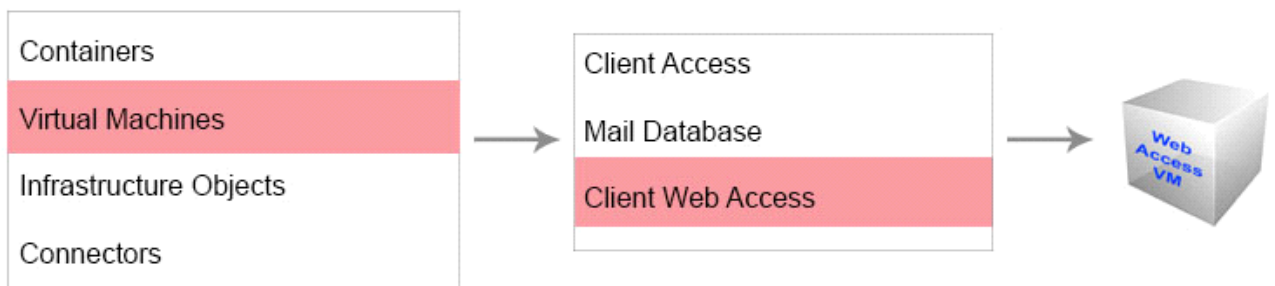
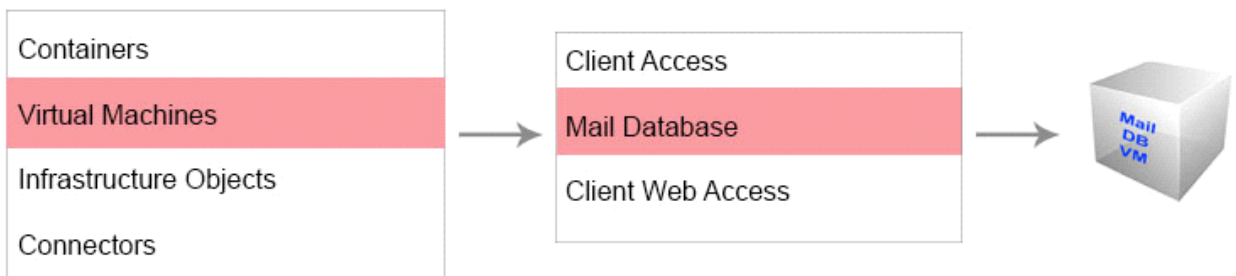
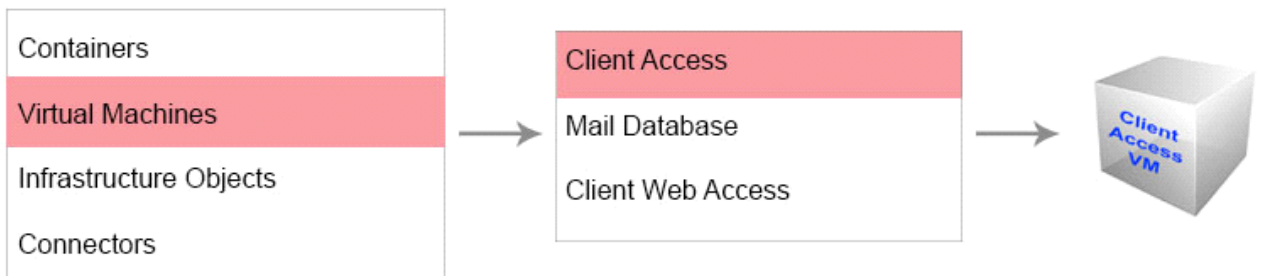
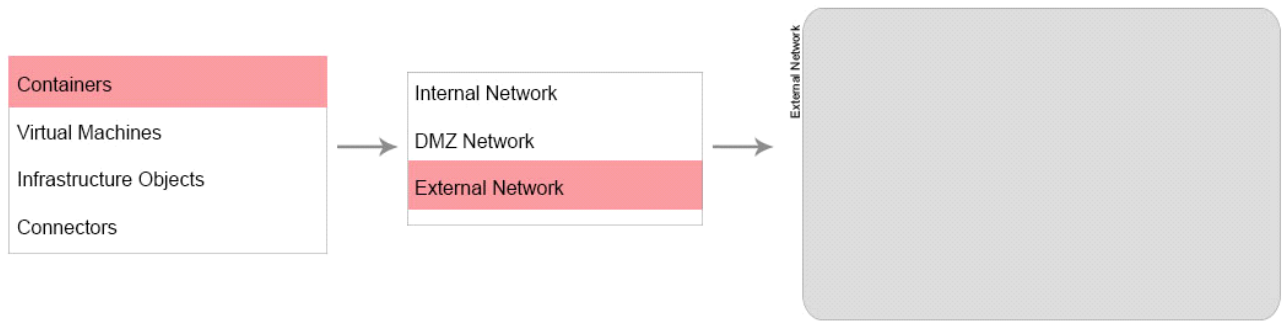

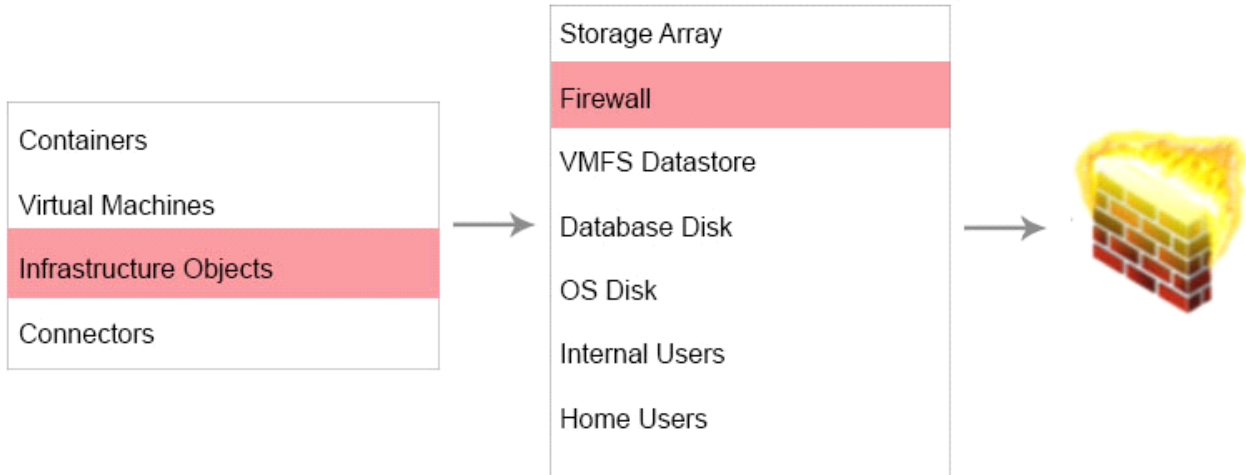
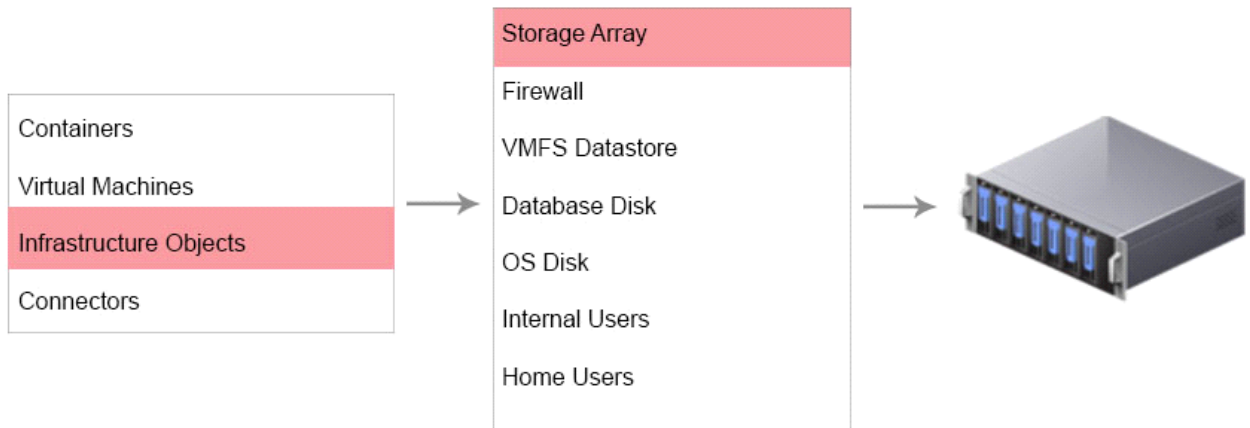

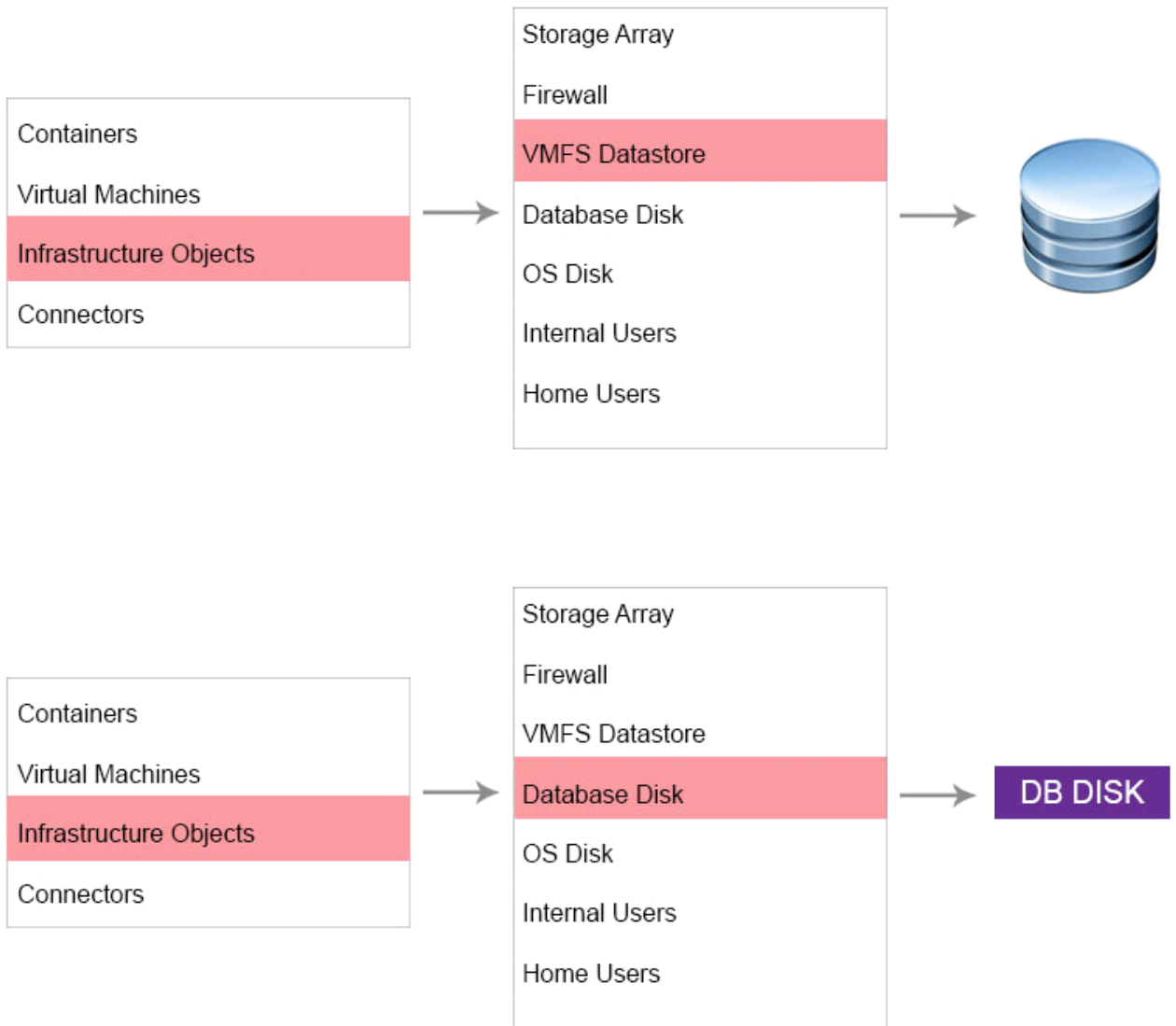

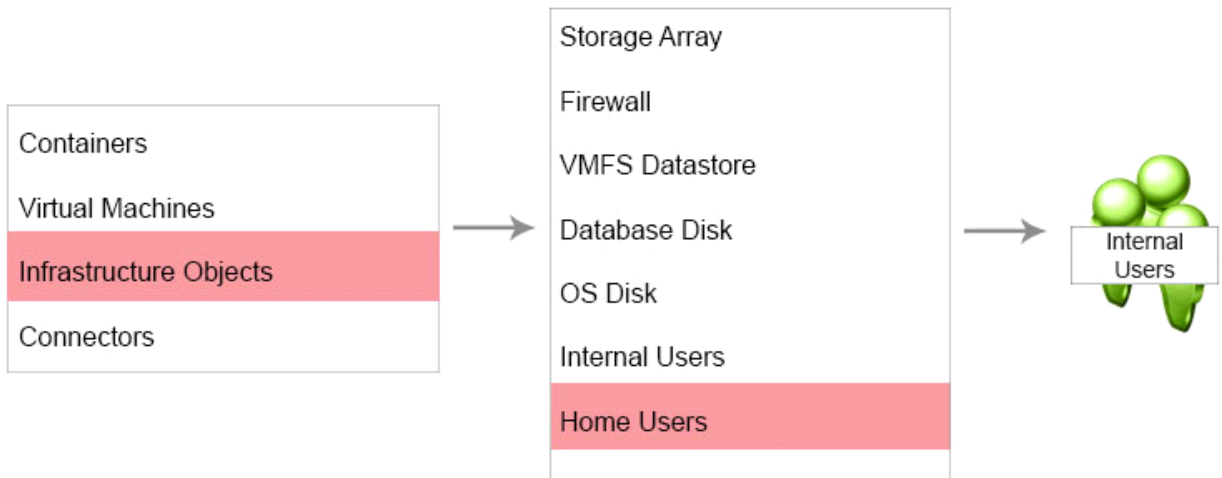
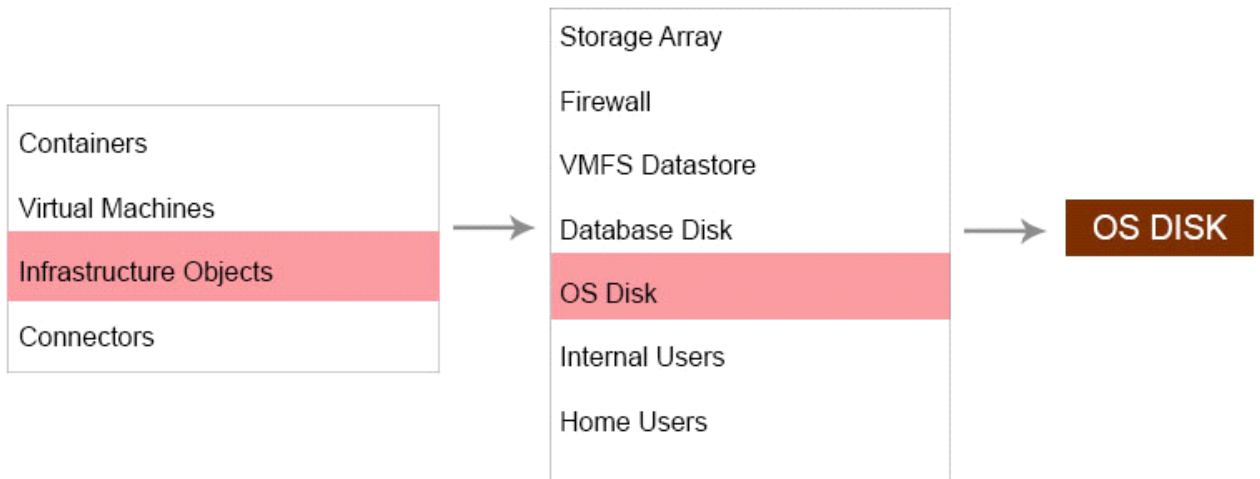

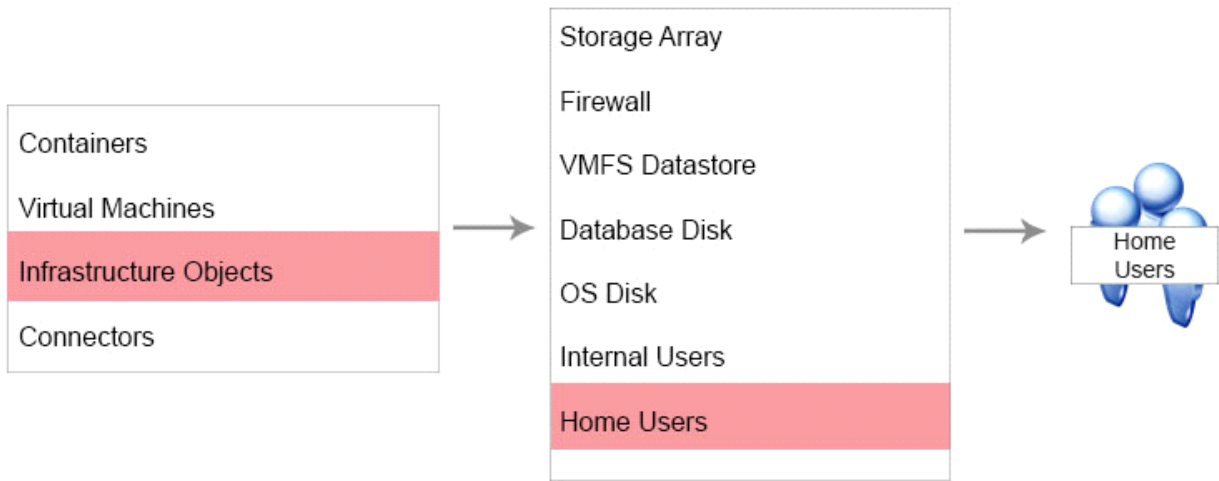

Answer:

Check below for answer solution

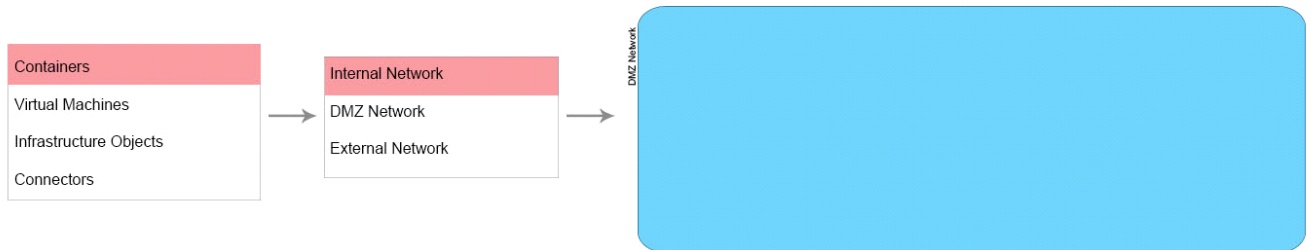

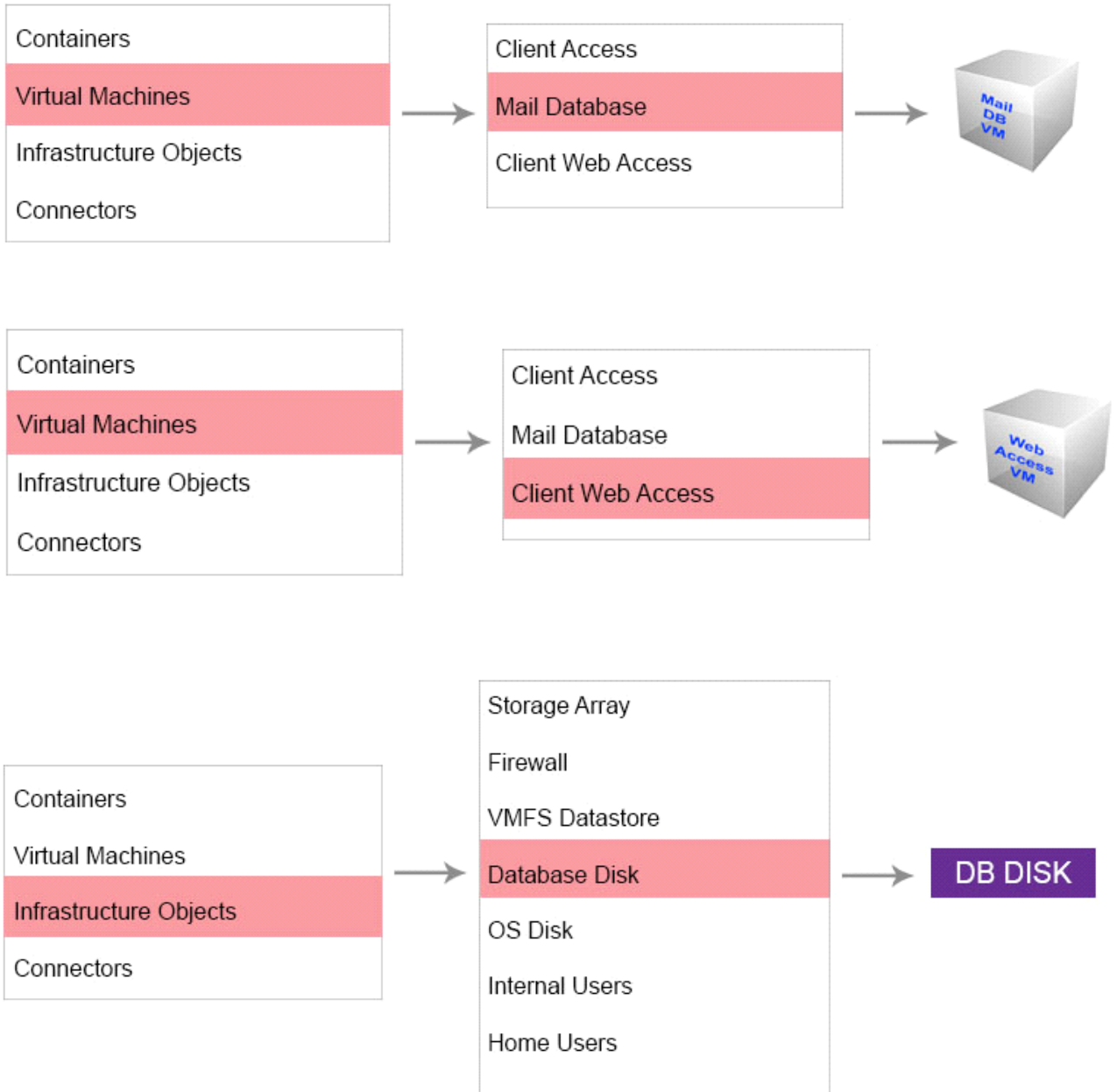

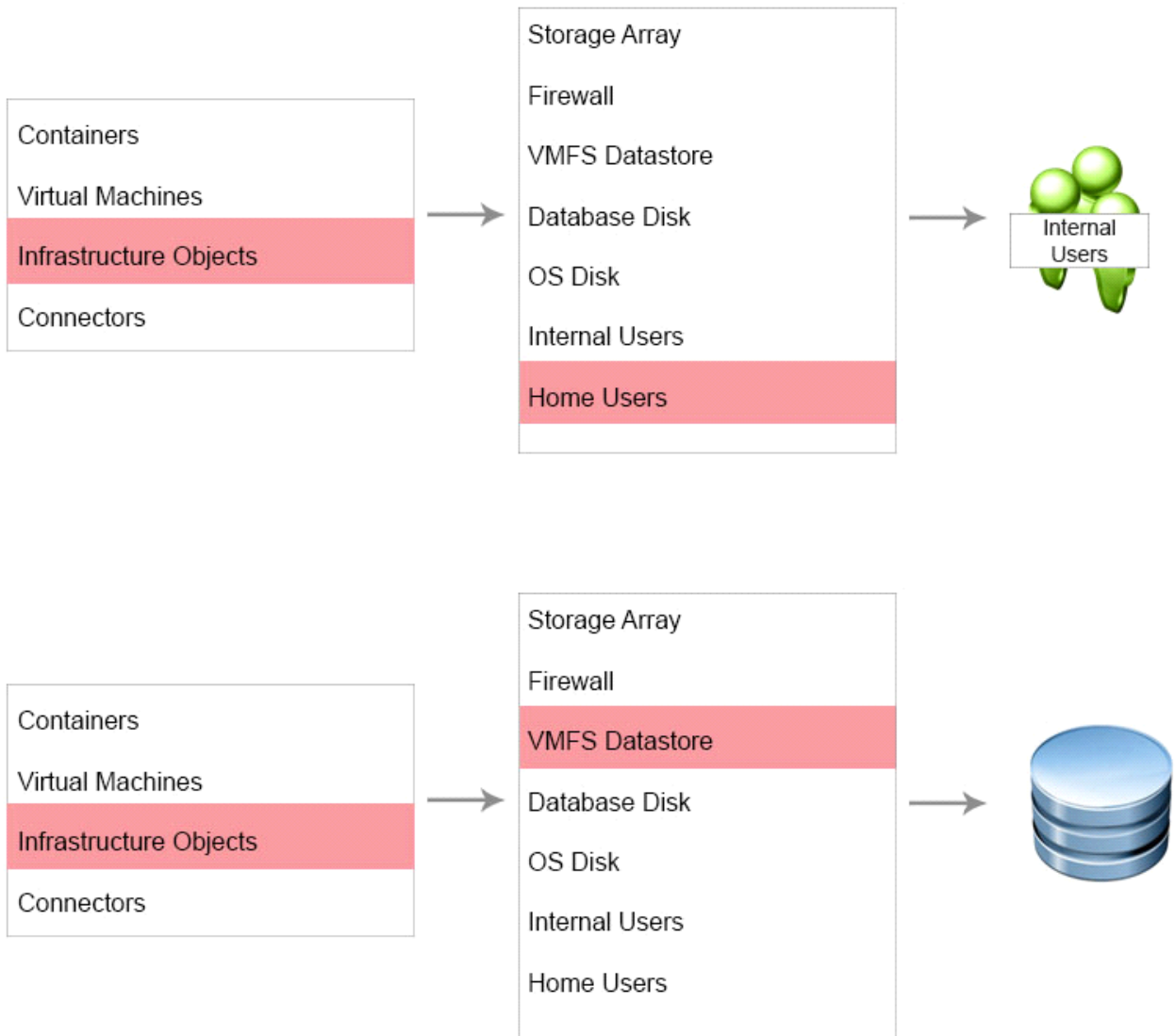

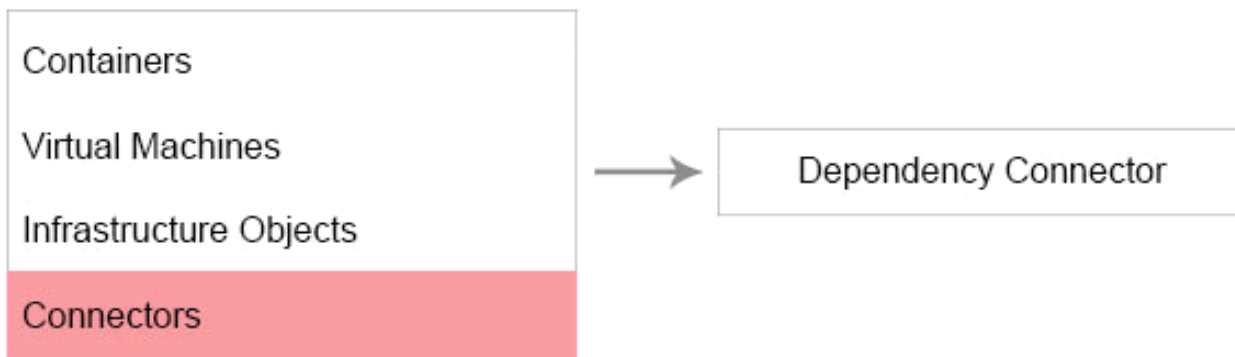

Thank You For Trying 3V0-622 PDF Demo

To try our 3V0-622 Premium Files visit link below:

<https://examsland.com/latest-exam-questions/3V0-622/>

Start Your 3V0-622 Preparation

Use Coupon **EL25 for extra 25% discount on the purchase of Practice Test Software.**